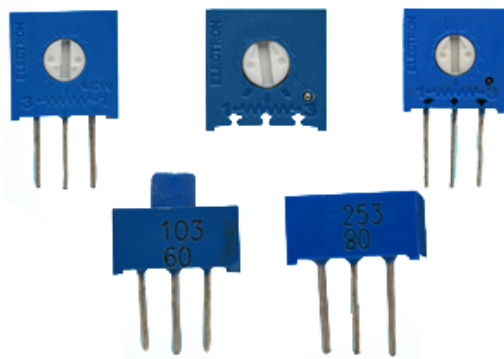

3386长柄方形单圈预调玻璃电位器
3386 Series Trimmer potentiometer

电气特性 Electrical Characteristics

标称阻值范围 (Standard Resistance Range)	100 Ω-2MΩ
阻止允许偏差 (Resistance Tolerance)	±5%, ±10%
终端电阻 (Terminal Resistance)	≤1%R或2Ω
接触电阻变化 (Contact Resistance Variation)	≤3%R或3Ω
绝缘电阻 (Insulation Resistance)	R ₁ ≥1GΩ
耐电压 (Withstand Voltage)	101.3kPa 600V 8.5kPa 250V
有效电行程 (Effective Electrical Travel)	260°

环境特性 Environment Characteristics

额定功率 (最高工作电压300V) (Rated Power)	+70℃ 0.5W; +125℃ 0W
工作温度范围 (Temperature Range)	-55℃~+125℃
电阻温度系数 (Temperature Coefficient)	±250、±100ppm/℃
温度变化 (Temperature Variation)	ΔR≤±2%R, Δ(U _{ab} /U _{ac}) ≤±5%
碰撞 (Vibration)	390m/s ² 、4000次 ΔR≤±3%R
振动 (Collision)	10~500HZ, 0.75mm或98m/s ² , 6h ΔR≤±1%R, Δ(U _{ab} /U _{ac}) ≤±2%
气候顺序 (Climate Category)	ΔR≤±3%R, R ₁ ≥100MΩ
70℃电气耐久度 (Electrical Endurance at 70℃)	0.5W、1000h、ΔR≤±3%R
机械耐久性 (Mechanical Endurance)	200圈 (cycles)、ΔR≤±3%R
稳态湿热 (Steady Damp-heat)	ΔR≤±3%R, R ₁ ≥100MΩ

物理特性 Physical Characteristics

总机械行程 (Total Mechanical Travel)	280°
起动力矩 (Starting Torque)	≤20mN.m
止档力矩 (Clutch Torque)	≥50mN.m
标准包装 (Standard Packaging)	50只/管 (pcs/tube)

3386G型

调节前 (ADJ. SLOT)
.76宽 (WIDE)
X .97深 (DEEP)
X 3.05长 (LONG)

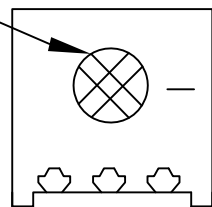

3.56±0.38

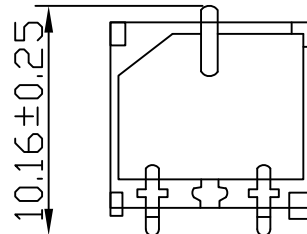
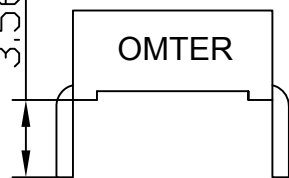

3386N型

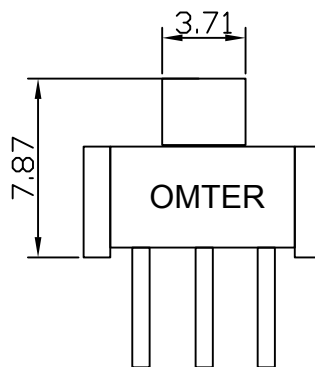
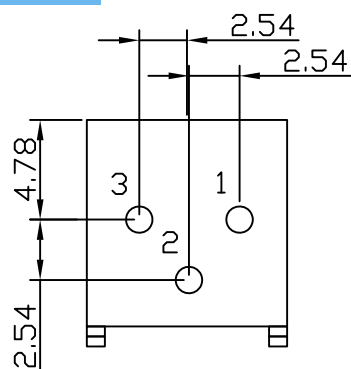

3386P-1型

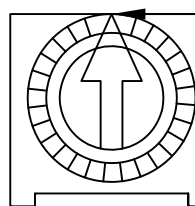
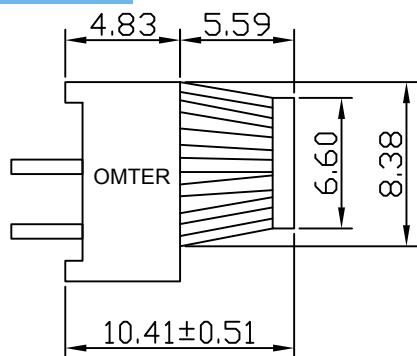

LONG长5.59
WIDE宽1.02
DEEP深1.40

3386P-2型

